

## AFPD006

6W CCT Selectable Slimline  
Flat Panel Downlight

## Orbit CCT 6

### PRODUCT FEATURES

- 5 Year Guarantee
- CCT Selectable (3000K/4000K/6000K)
- UV Stable
- Flicker Free Driver
- Low Glare Edge-Lit Design
- Slimline Design
- Ideal For Use In Shallow Ceiling Voids
- High Luminous Efficiency
- Plug & Play DC Connector Driver
- Uniform Light Output
- 0-10V & DALI Dimmable Options Available

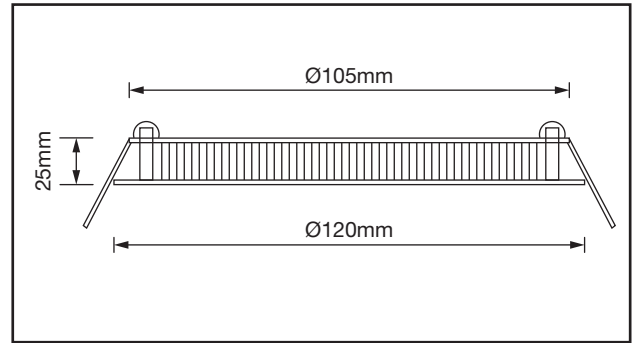

### TECHNICAL SPECIFICATIONS

PRODUCT CODE	AFPD006/CCT
Frame Colour	White
Wattage	6W
Operating Voltage	220 - 240VAC
Frequency	50-60Hz
CCT	3000K, 4000K, 6000K
CRI	>80
Power Factor	>0.5
Beam Angle	120°
Peak Intensity	235cd
Lifetime To LM80	30,000 Hrs
Useful Luminous Flux (LM)	≤460lm
Switching Cycles	<15,000
Ambient Operating Temperature	-20 ~ 50°C
SDCM	<8
Starting Time	Instant Start
Ingress Protection	IP20
LED Chips	SMD2835
Guarantee	5 Years
Cut Out	Ø105mm
Overall Diameter	Ø120mm
Class Driver	II
Class Downlight	III

**Standard**  
AFDP006/CCT

**Mains Dimmable**  
AFDP006TD/CCT

**DALI**  
AFDP006/CCT/DALI

**0-10V Dimmable**  
AFDP006/CCT/0-10

**Standard  
Emergency**  
AFDP006/CCT/EM

**Mains Dimmable  
Emergency**  
AFDP006TD/CCT/EM

**DALI  
Emergency**  
AFDP006/CCT/DALI/EM

**0-10V Dimmable  
Emergency**  
AFDP006/CCT/0-10/EM

